

## 使用 XL4301 和 NT6008 设计的兼容 Quick Charge 3.0 的车载充电器

### 描述

本文介绍的是使用 XL4301 和 NT6008 设计的 Quick Charge 3.0 的车载充电器演示板(同时兼容 Quick Charge 2.0), 输出电压 3.6-12V, 以 200mV 每档步进, 最大输出电流 2.4A 的车载快充应用, 最高转换效率可以达到 95% 以上。

XL4301 是开关降压型 DC-DC 转换芯片, 内部集成功率 MOSFET; 固定开关频率 180KHz, 可减小外部元器件尺寸。芯片具有出色的线性调整率与负载调整率, 输入电压最高可达 40V。芯片内部集成过流保护、过温保护、短路保护等可靠性模块。

此方案默认输出电压为 5V, 可通过负载结合 NT6008 进行逻辑判断, 自动调整输出电压; 可支持苹果、安卓、BC1.2 和 YD/T 1591 等充电协议。

XL4301 为 SOP8-EP 封装, 采用标准外部元器件, 应用灵活。

### 电源规格

说明		符号	最小值	典型值	最大值	单位	备注
输入	输入电压	VIN	10		40	VDC	
输出	输出电压 1	VOUT1		5		V	
	输出电流 1	IOUT1			2.4	A	
	输出纹波电压 1	VRIPPLE1		66		mVPP	20MHz 带宽
	输出电压 2	VOUT2		9		V	
	输出电流 2	IOUT2			1.8	A	
	输出纹波电压 2	VRIPPLE2		50		mVPP	20MHz 带宽
	输出电压 3	VOUT3		12		V	输入电压大于 13V
	输出电流 3	IOUT3			1.8	A	
效率	VOUT=5V	η		89		%	VIN=12V, 满载
	VOUT=9V			94			VIN=12V, 满载
	VOUT=12V			96			VIN=14V, 满载

### 电路原理图

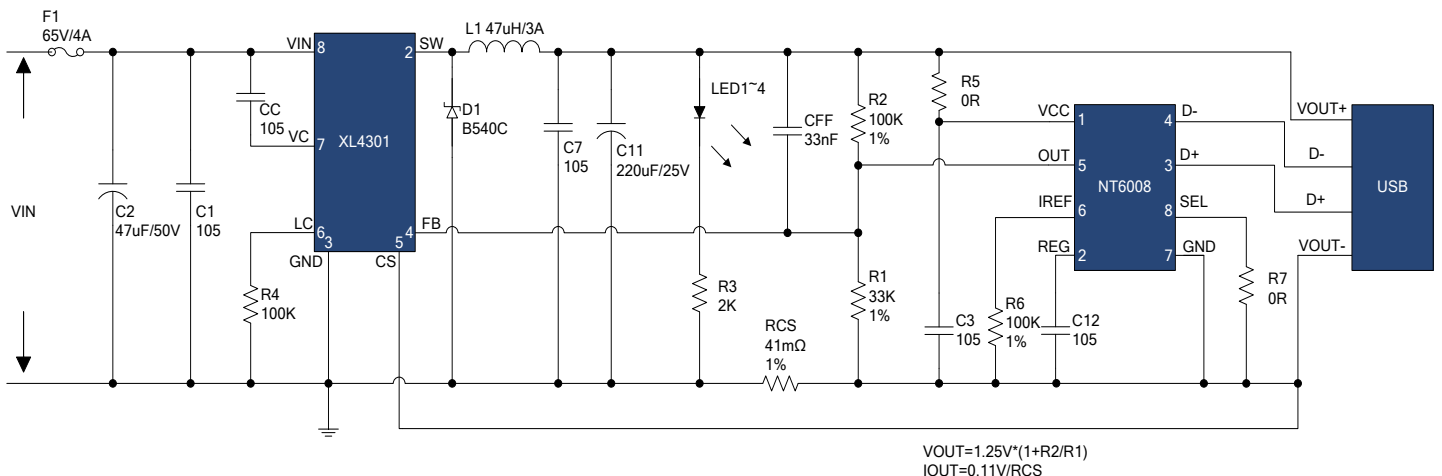

**物料清单**

序号	数量	参考位号	说明	生产商型号	生产商
1	5	C1,C3,C7,C12,CC	1uF,50V,Ceramic,X7R,0805	C2012X7R1H105K	TDK
2	1	C2	47uF,50V,Electrolytic,(6.3*11)	YXJ-50V-47uF	Rubycon
3	1	C11	220uF,25V,Electrolytic,(6.3*11)	YXJ-25V-220uF	Rubycon
4	1	CFF	33nF,50V,Ceramic,X7R,0603	C1608X7R1H333K	TDK
5	1	D1	40V,5A,Schottky Barrier Rectifier,SMC	B540C	DIODES
6	1	F1	4A,65V,Fast acting,1206	F1206F4.00TM	DEEP
7	1	L1	47uH,3A,(13*7)	-	-
8	4	LED1-4	Blue,0805,SMD	-	-
9	1	R1	33KΩ,1%,1/16W,Thick Film,0603	RC0603XR-073302L	Yageo
10	3	R2,R4,R6	100KΩ,1%,1/16W,Thick Film,0603	RC0603XR-071003L	Yageo
11	1	R3	2KΩ,1%,1/16W,Thick Film,0603	RC0603XR-072001L	Yageo
12	2	R5,R7	0Ω,1%,1/16W,Thick Film,0603	-	Yageo
13	2	RCS1,RCS2	0.082Ω,1%,1/4W,Thick Film,1206	RC1206XR-07R082L	Yageo
14	1	U1	40V,3A,180K,BUCK,DC-DC Converter,SOP8-EP	XL4301	XLSEMI
15	1	U2	Charger Interface Physical Layer IC,TSOT23-8L	NT6008	EOSMEM
16	1	USB	DIP		

**电路板实物图**

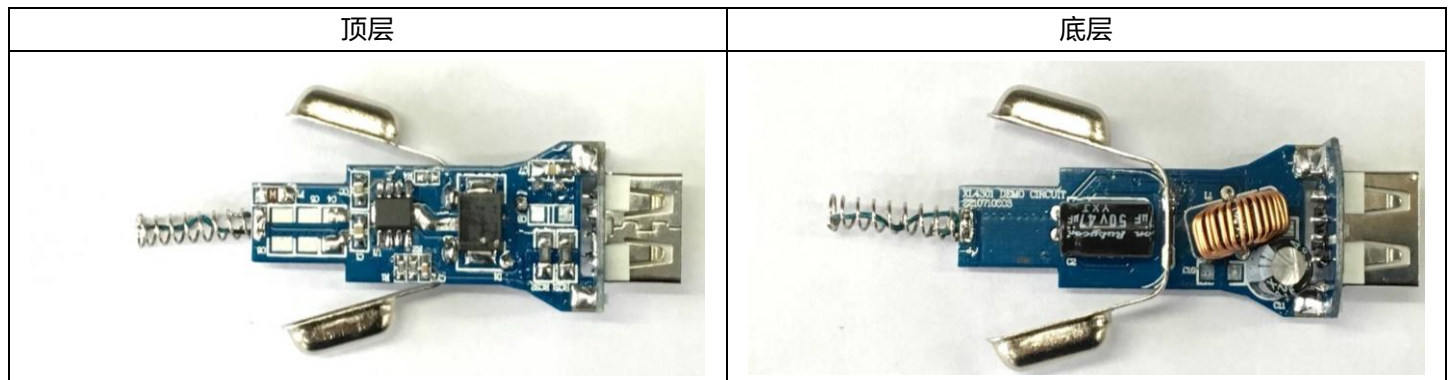

PCB 布局

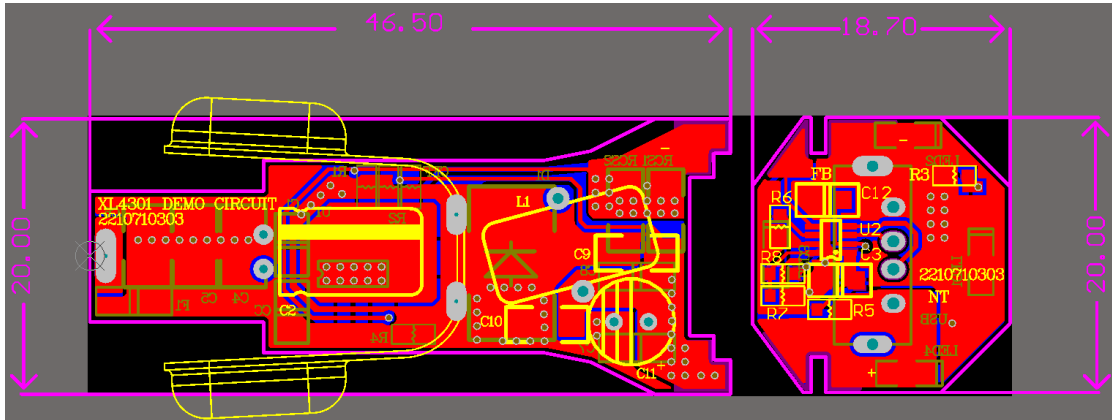

顶层

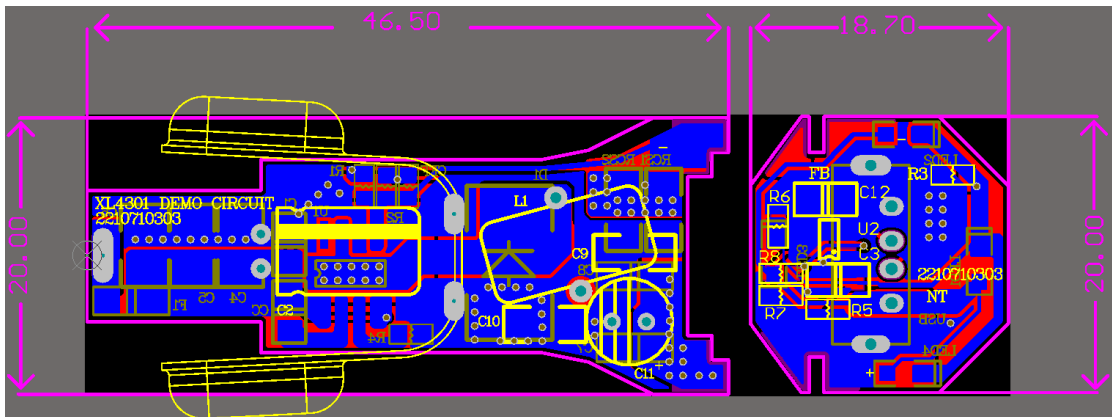

底层

性能数据

转换效率

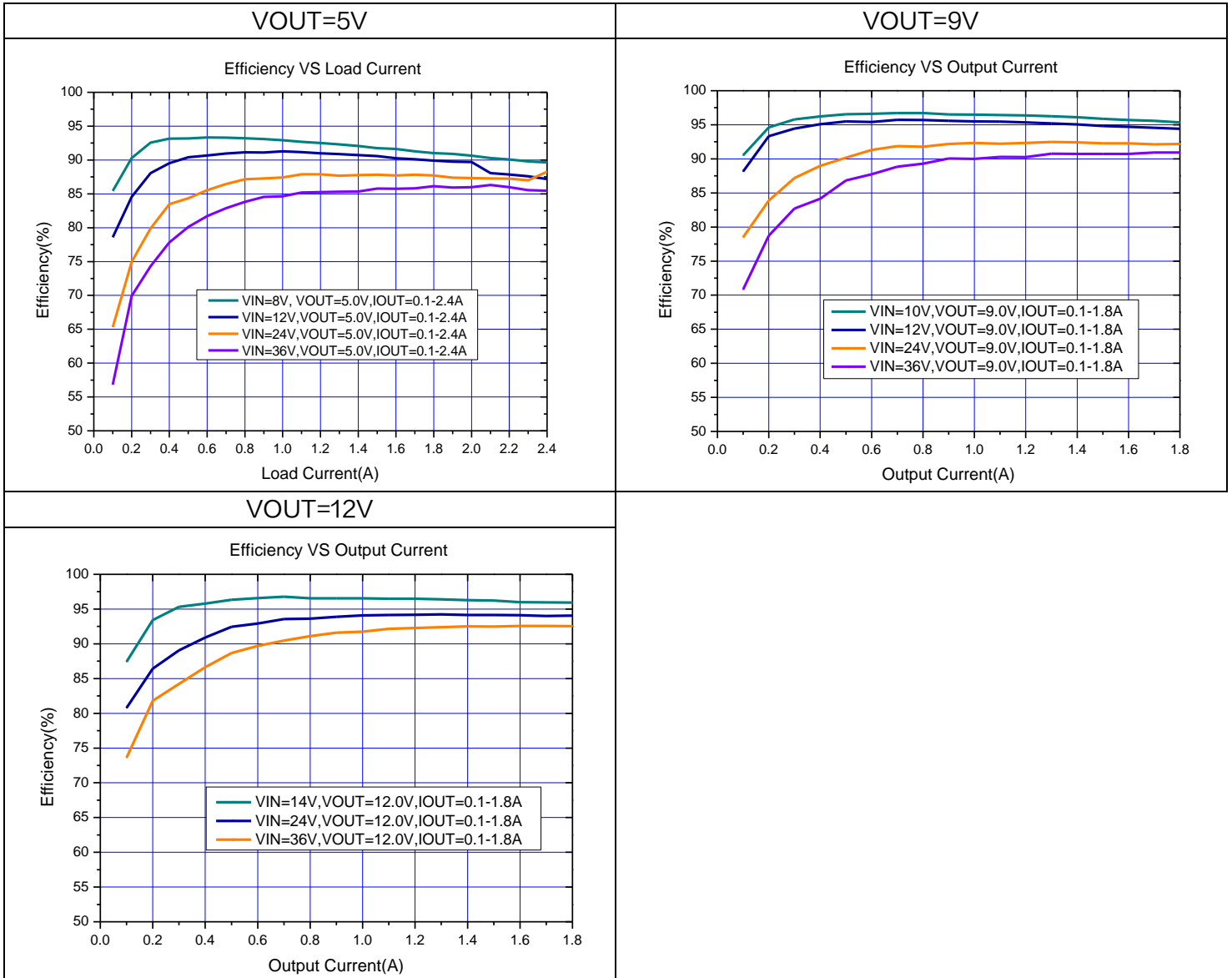

输出电压步进 (VOUT=5V 为步长参考 0 点)

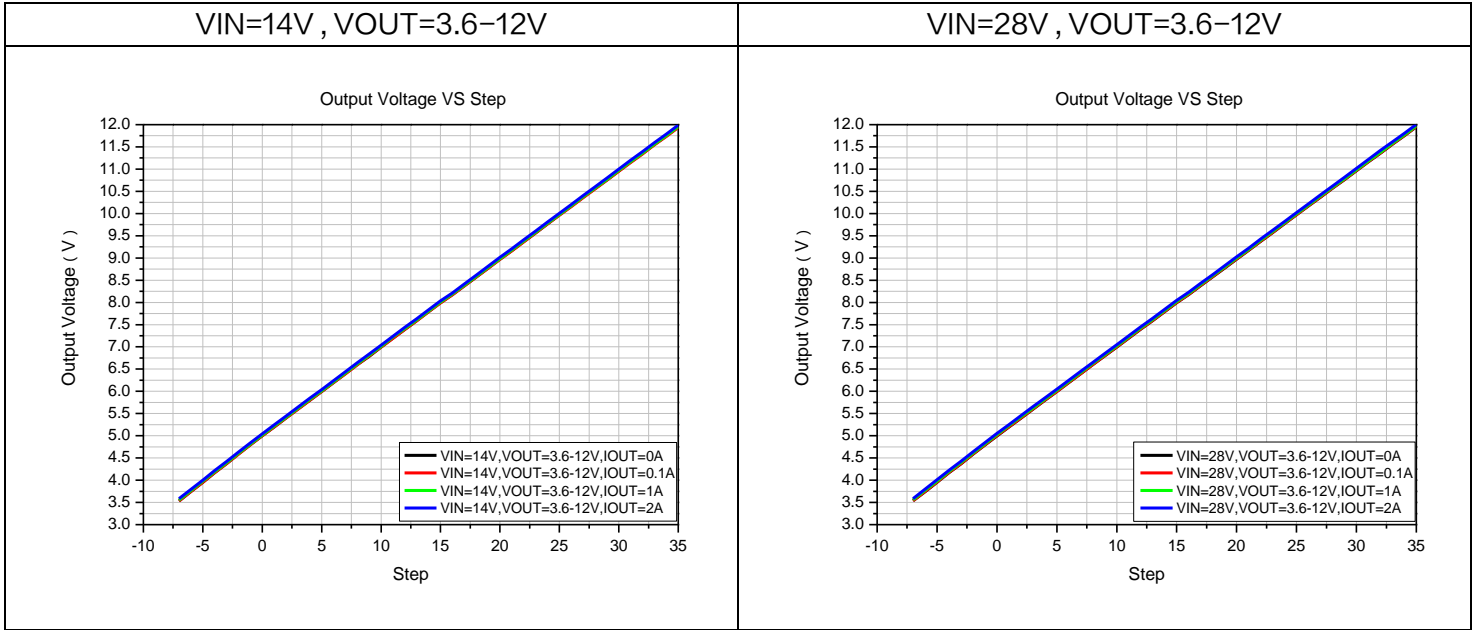

线性调整率与负载调整率

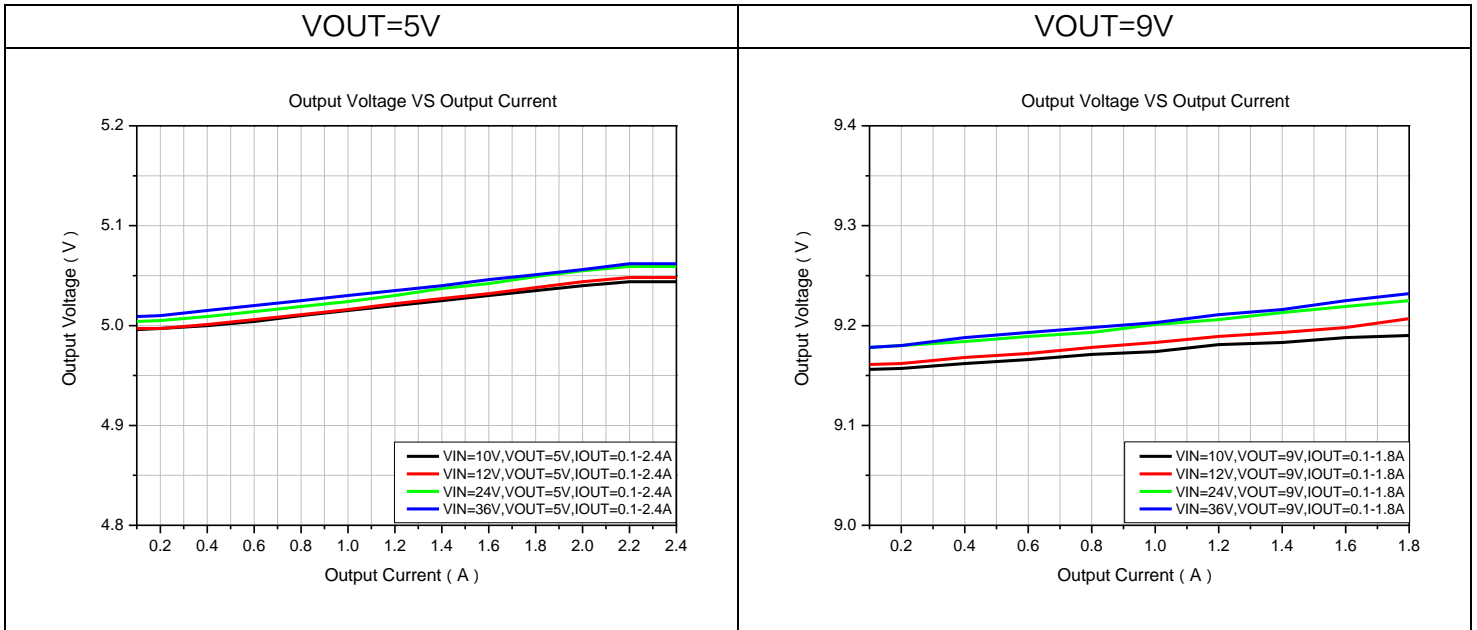

热性能

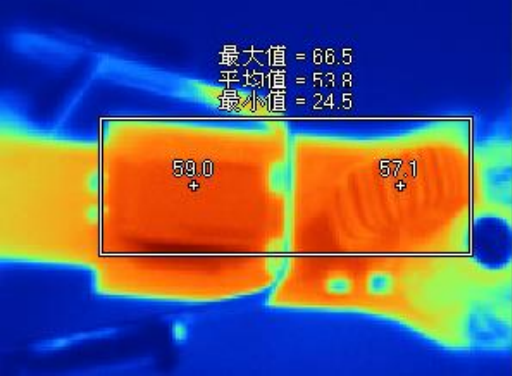
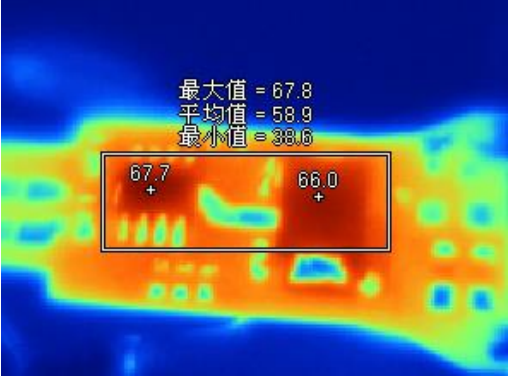
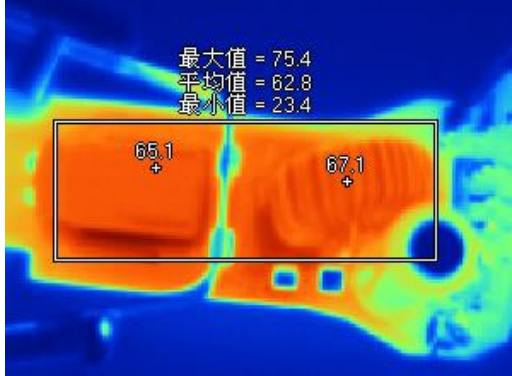
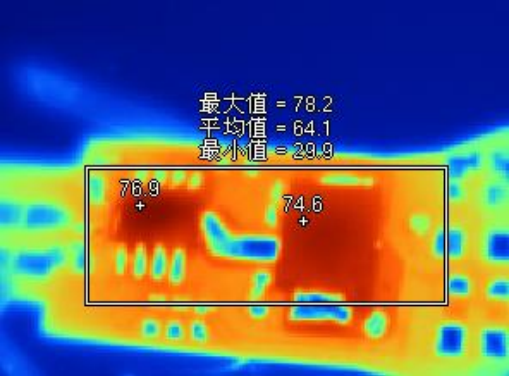
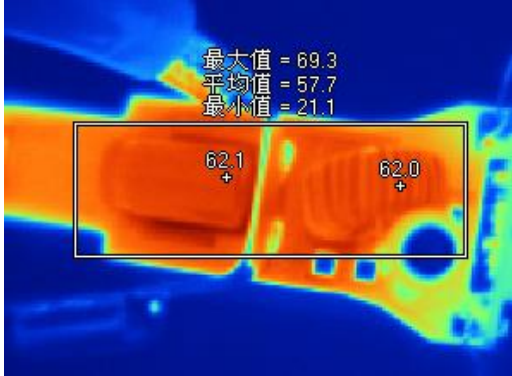
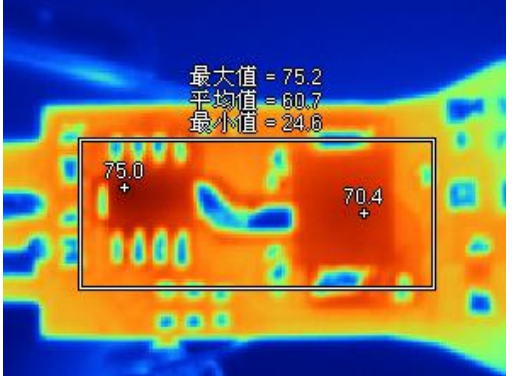
测试条件	顶层	底层
VIN=14V VOUT=5V IOUT=2.1A TA=15°C	 <p>最大值 = 66.5 平均值 = 53.8 最小值 = 24.5</p> <p>59.0 +</p> <p>57.1 +</p>	 <p>最大值 = 67.8 平均值 = 58.9 最小值 = 38.6</p> <p>67.7 +</p> <p>66.0 +</p>
VIN=28V VOUT=5V IOUT=2.1A TA=15°C	 <p>最大值 = 75.4 平均值 = 62.8 最小值 = 23.4</p> <p>65.1 +</p> <p>67.1 +</p>	 <p>最大值 = 78.2 平均值 = 64.1 最小值 = 29.9</p> <p>76.9 +</p> <p>74.6 +</p>
VIN=14V VOUT=5V IOUT=2.4A TA=15°C	 <p>最大值 = 69.3 平均值 = 57.7 最小值 = 21.1</p> <p>62.1 +</p> <p>62.0 +</p>	 <p>最大值 = 75.2 平均值 = 60.7 最小值 = 24.6</p> <p>75.0 +</p> <p>70.4 +</p>

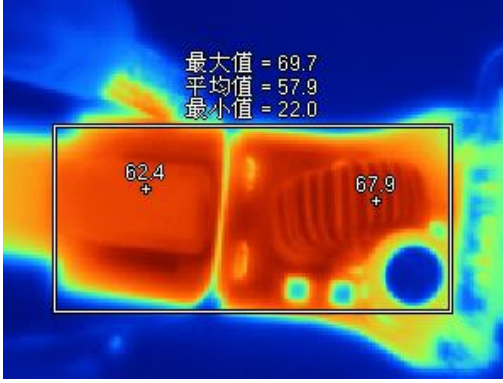
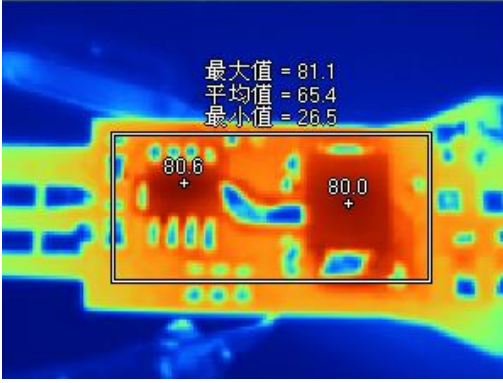
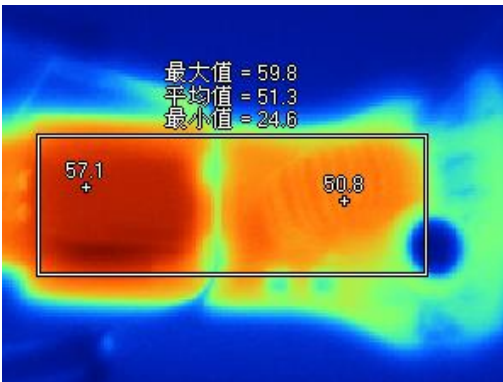
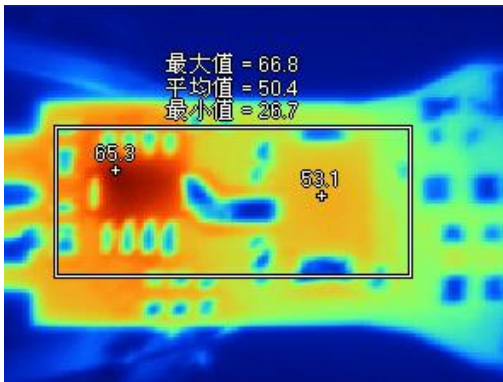
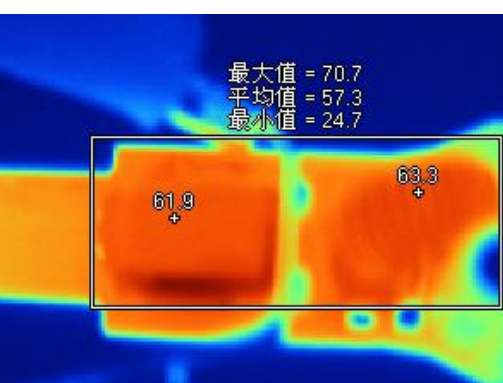
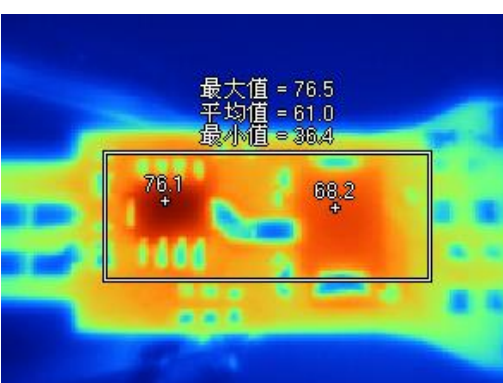

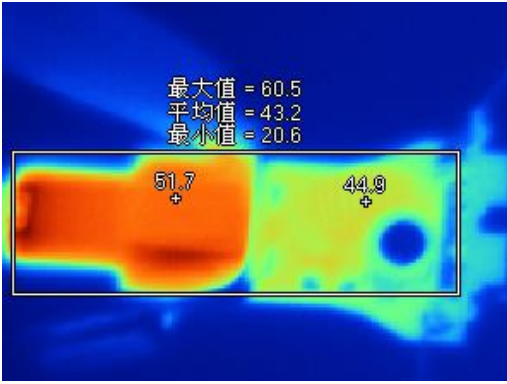
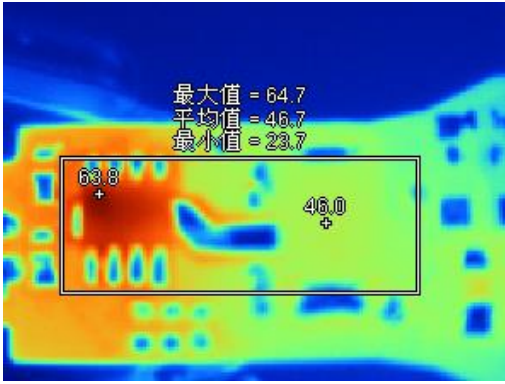
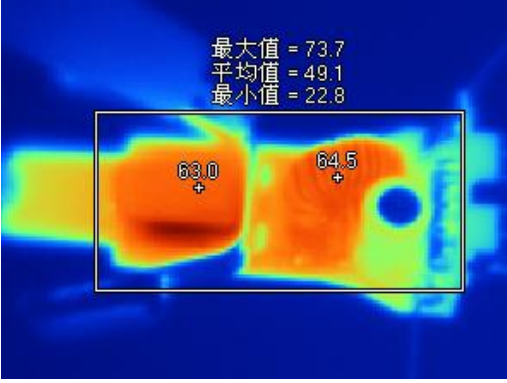
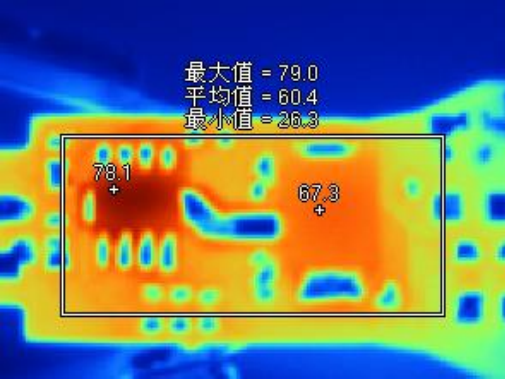

<p>VIN=28V VOUT=5V IOUT=2.4A TA=15°C</p>	 <p>最大值 = 69.7 平均值 = 57.9 最小值 = 22.0</p> <p>62.4 +</p> <p>67.9 +</p>	 <p>最大值 = 81.1 平均值 = 65.4 最小值 = 26.5</p> <p>80.6 +</p> <p>80.0 +</p>
<p>VIN=14V VOUT=9V IOUT=1.8A TA=15°C</p>	 <p>最大值 = 59.8 平均值 = 51.3 最小值 = 24.6</p> <p>57.1 +</p> <p>50.8 +</p>	 <p>最大值 = 66.8 平均值 = 50.4 最小值 = 23.7</p> <p>65.3 +</p> <p>53.1 +</p>
<p>VIN=28V VOUT=9V IOUT=1.8A TA=15°C</p>	 <p>最大值 = 70.7 平均值 = 57.3 最小值 = 24.7</p> <p>61.9 +</p> <p>63.3 +</p>	 <p>最大值 = 76.5 平均值 = 61.0 最小值 = 36.4</p> <p>76.1 +</p> <p>68.2 +</p>

<p>VIN=14V VOUT=12V IOUT=1.8A TA=15°C</p>		
<p>VIN=28V VOUT=12V IOUT=1.8A TA=15°C</p>		

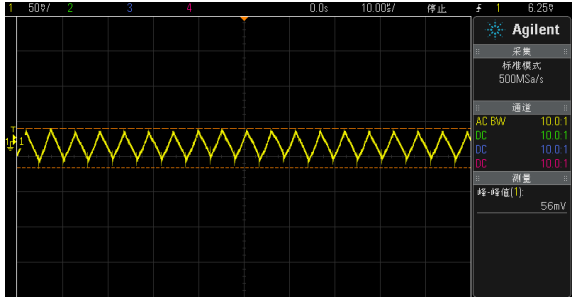
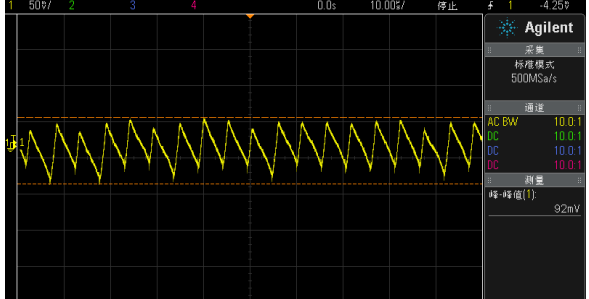

**波形**

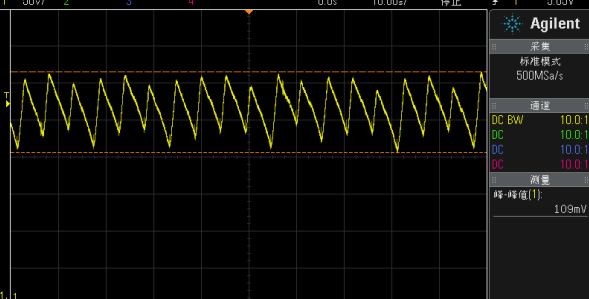
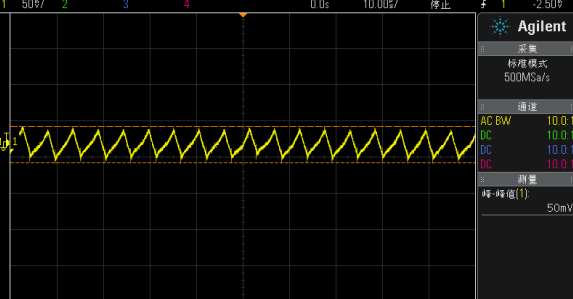
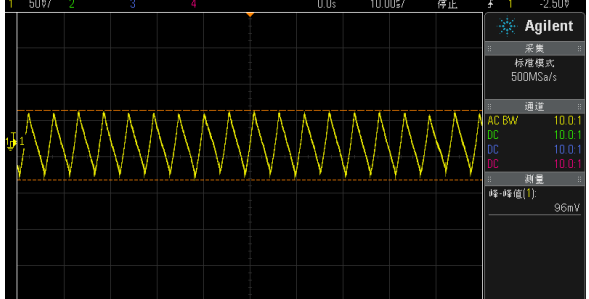
输出纹波电压

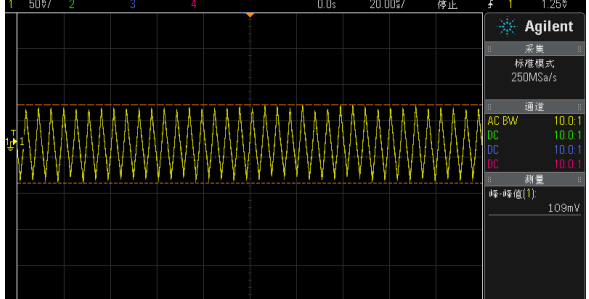
测试条件	VIN=14V	VIN=28V
VOUT=5V IOUT=2.1A		
VOUT=5V IOUT=2.4A		
VOUT=9V IOUT=1.8A		
VOUT=12V IOUT=1.8A		

输出电压

测试条件	VIN=14V	VIN=28V
VOUT=5V IOUT=2.1A		
备注	黄色通道为输出电压波形，绿色通道为输入电压波形	

输出电压切换

测试条件	VIN=14V	VIN=28V
IOUT=2A VOUT: 5V→5.2V		
测试条件	VIN=14V	VIN=28V
IOUT=2A VOUT: 5V→4.8V		